

REITER
GLASS WALL

SECCION VERTICAL DEL CARRIL
ENCASTRADO EN FALSO TECHO

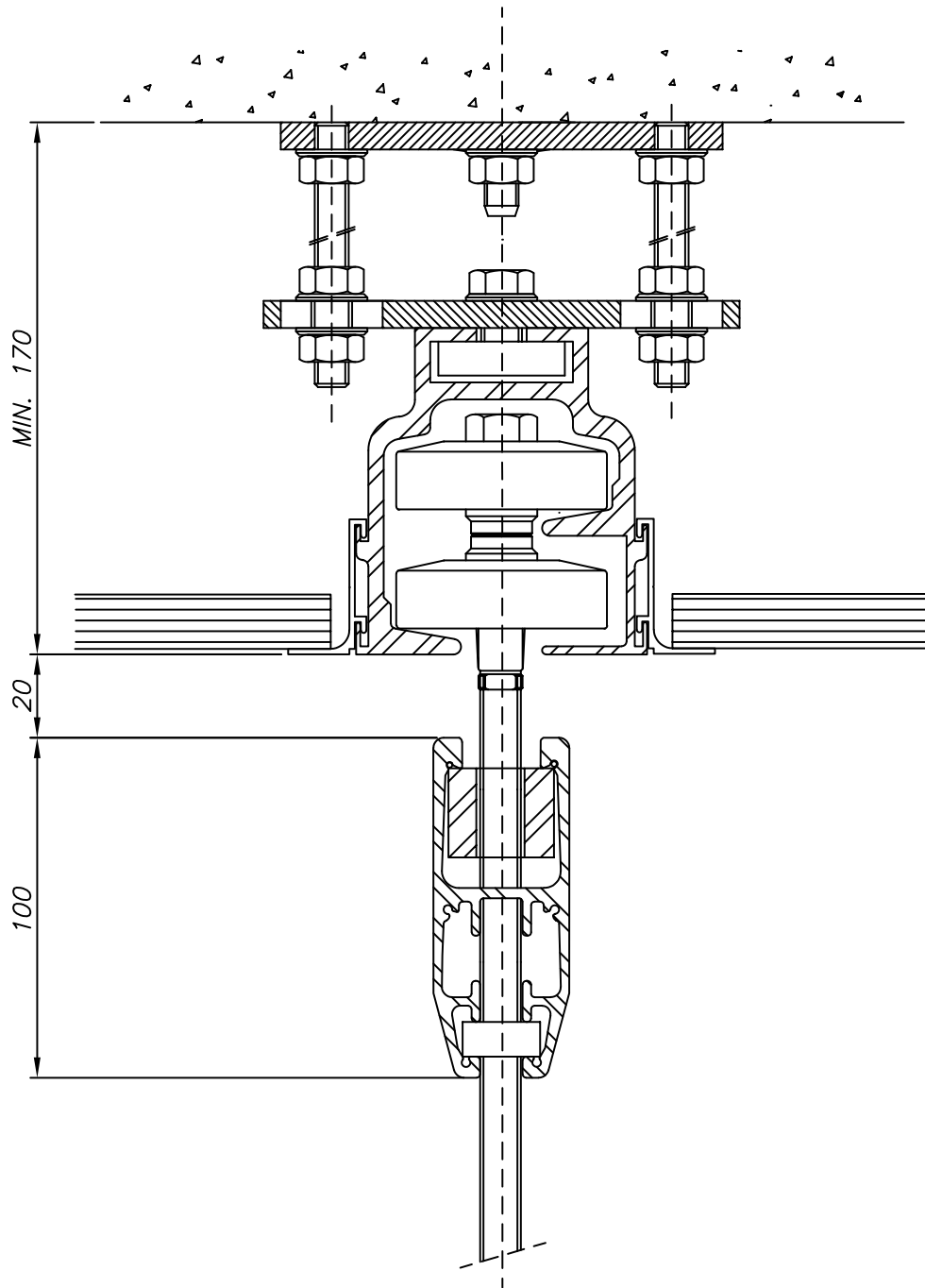

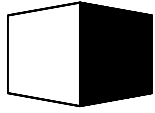

REITER
GLASS WALL

SECCION VERTICAL DEL
CARRIL APARENTE

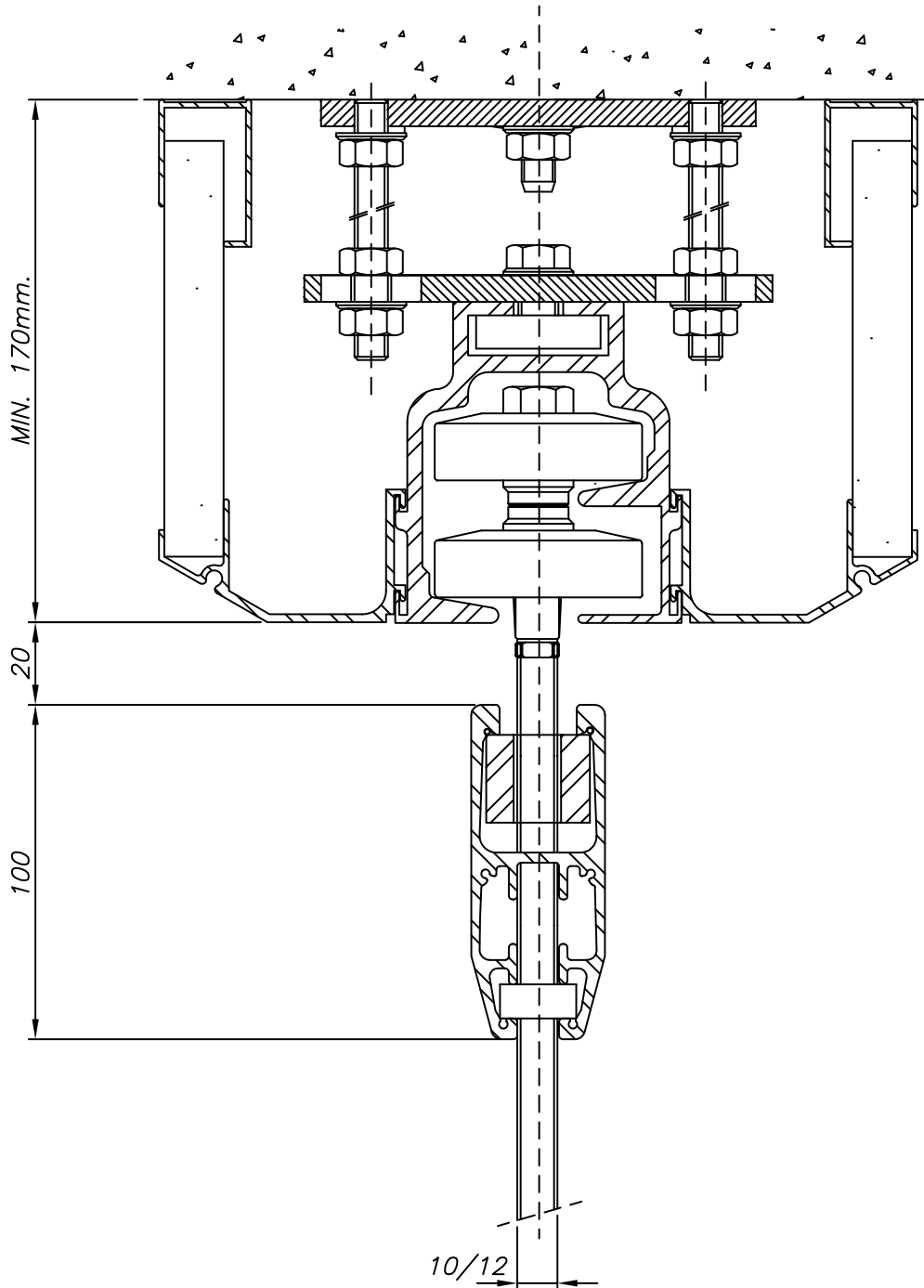

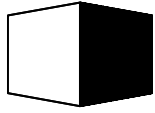

REITER
GLASS WALL

CORTE VERTICAL DE MÓDULO

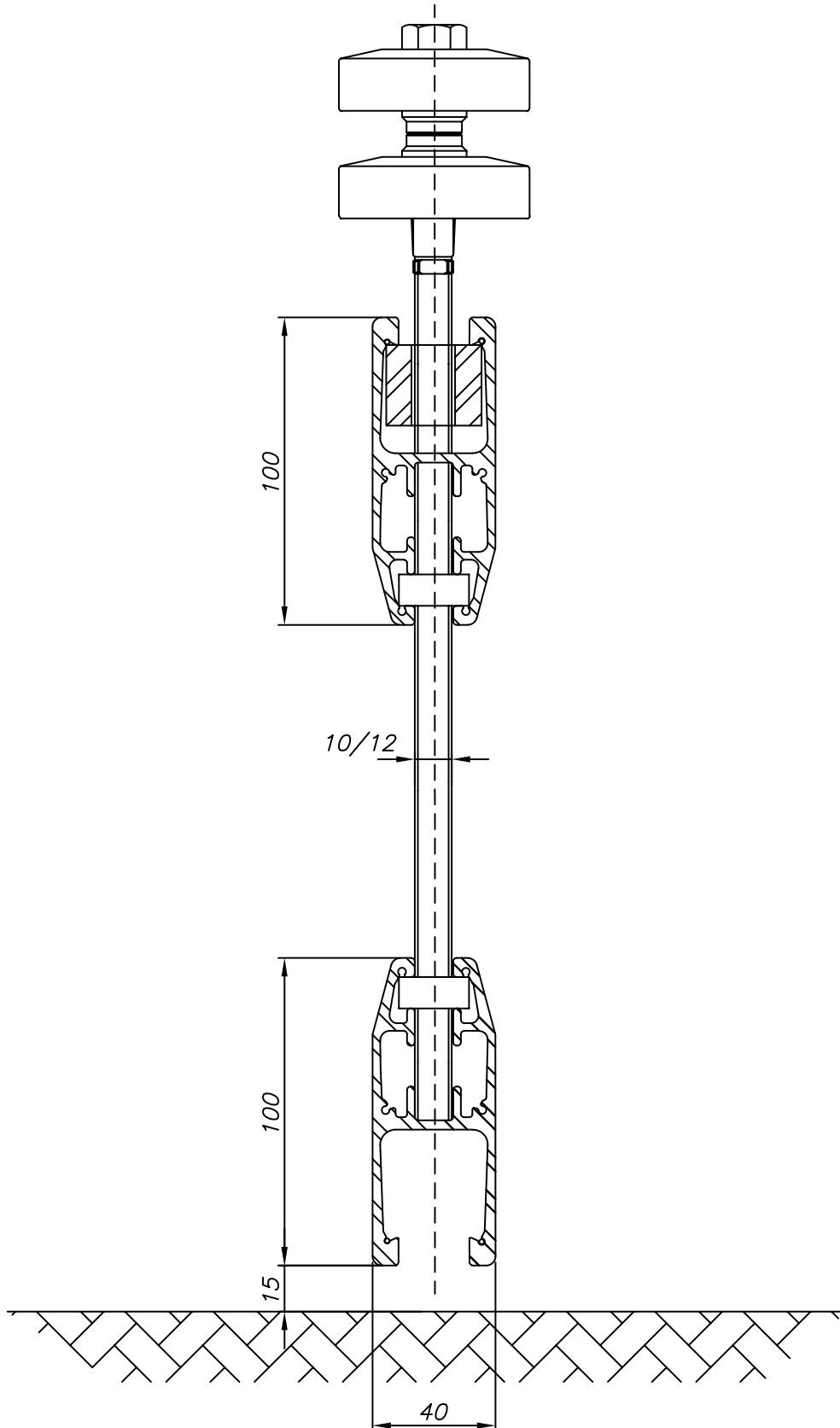

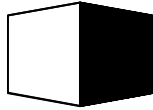

REITER
GLASS WALL

TABIQUE MOVIL ACRISTALADO ENTRE PAREDES

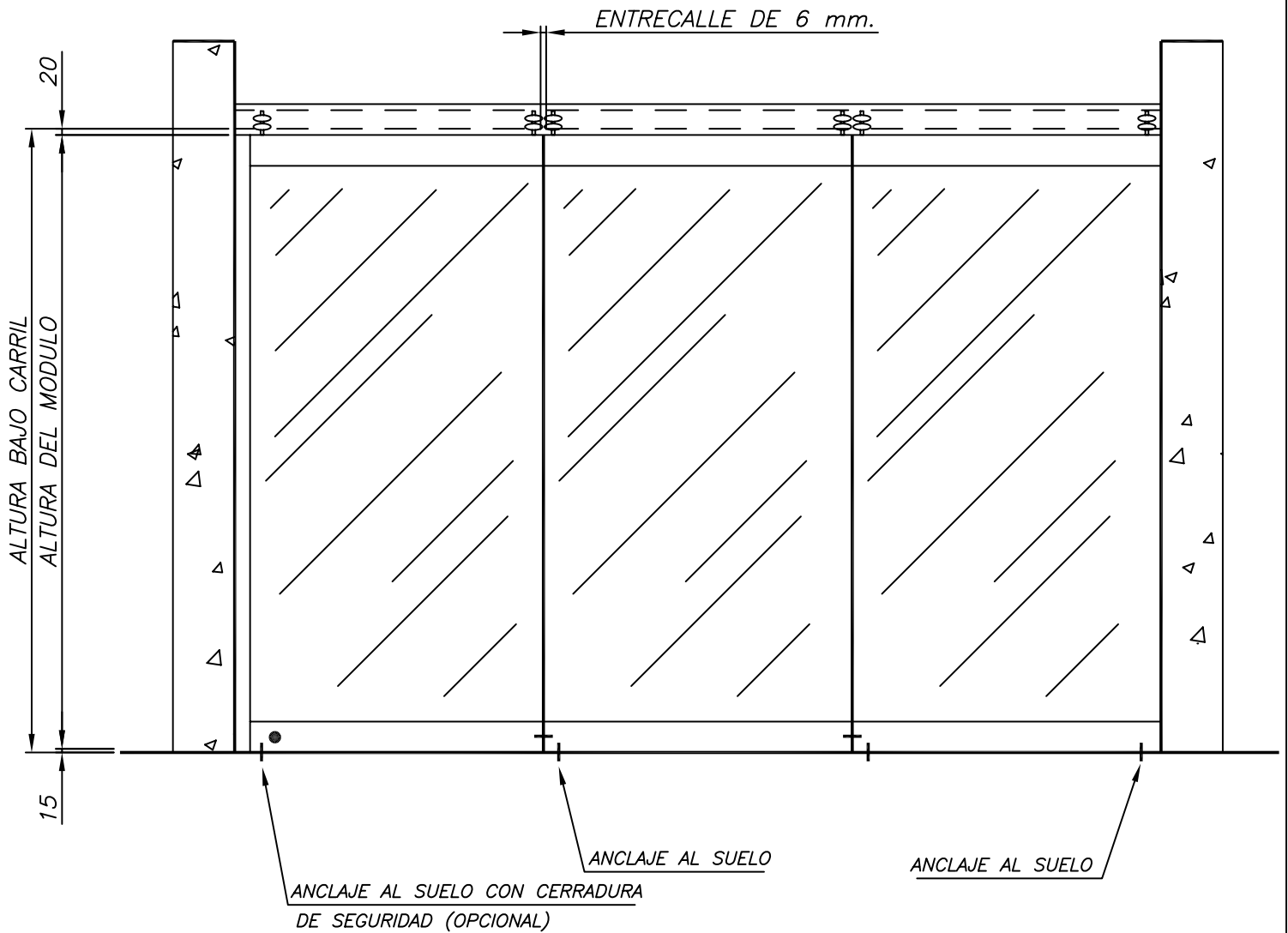

	H. MAX. BAJO CARRIL	ANCHO MAX.
MODULO SIMPLE	3400 mm.	1300 mm.
MODULO BATIENTE	3000 mm.	1000 mm.
MODULO PUERTA	3000 mm.	800 mm.
MODULO PUERTA DOBLE	3000 mm.	800 mm.
CONSULTAR MEDIDAS ESPECIALES		

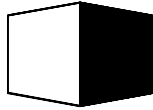

REITER
GLASS WALL

TABIQUE MOVIL ACRISTALADO DELANTE DE PAREDES

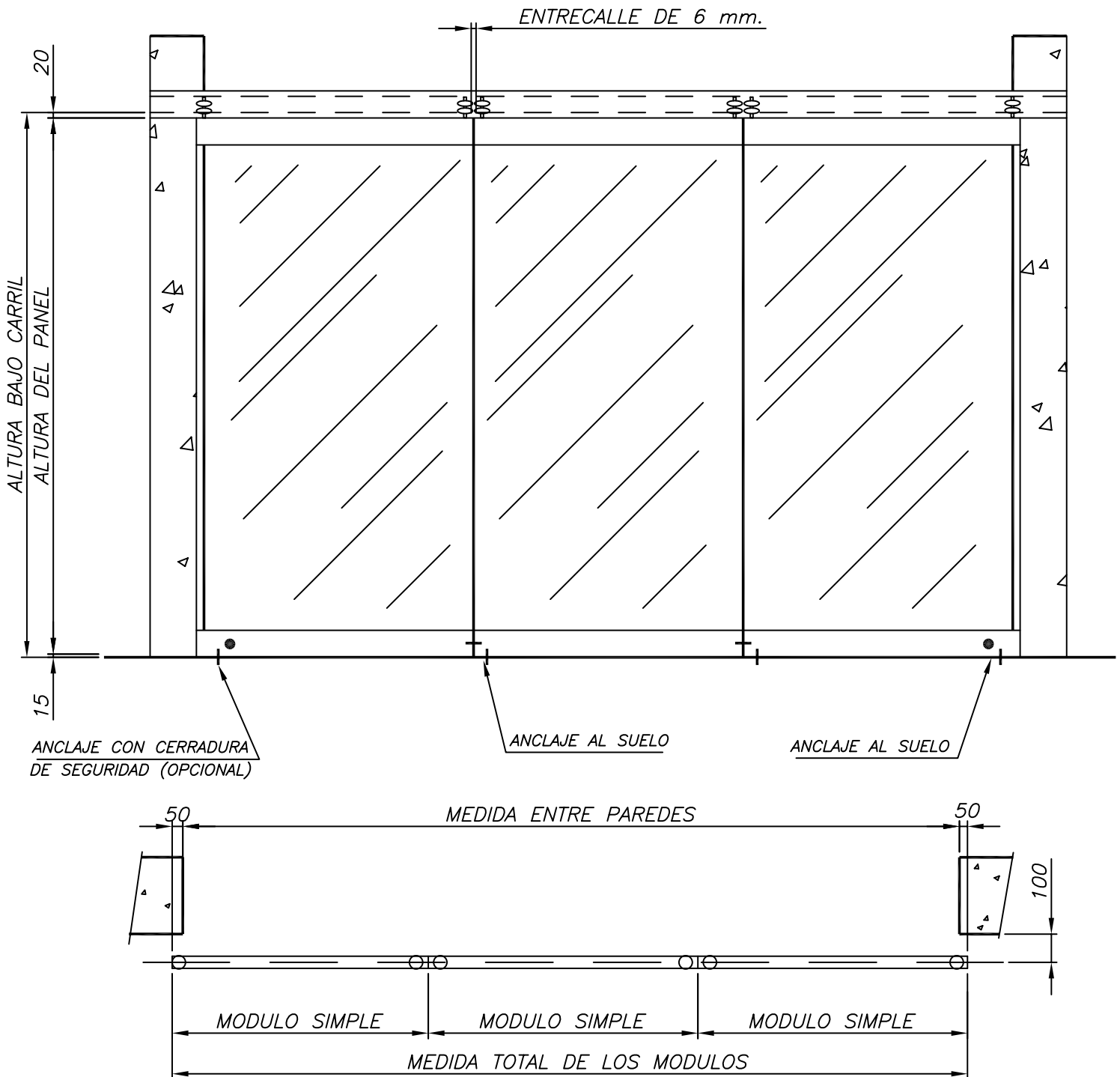

	H. MAX. BAJO CARRIL	ANCHO MAX.
MODULO SIMPLE	3400 mm.	1300 mm.
MODULO BATIENTE	3000 mm.	1000 mm.
MODULO PUERTA	3000 mm.	800 mm.
MODULO PUERTA DOBLE	3000 mm.	800 mm.
CONSULTAR MEDIDAS ESPECIALES		

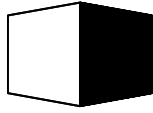

REITER
GLASS WALL

TABIQUE MOVIL ACRISTALADO CON MODULO BATIENTE

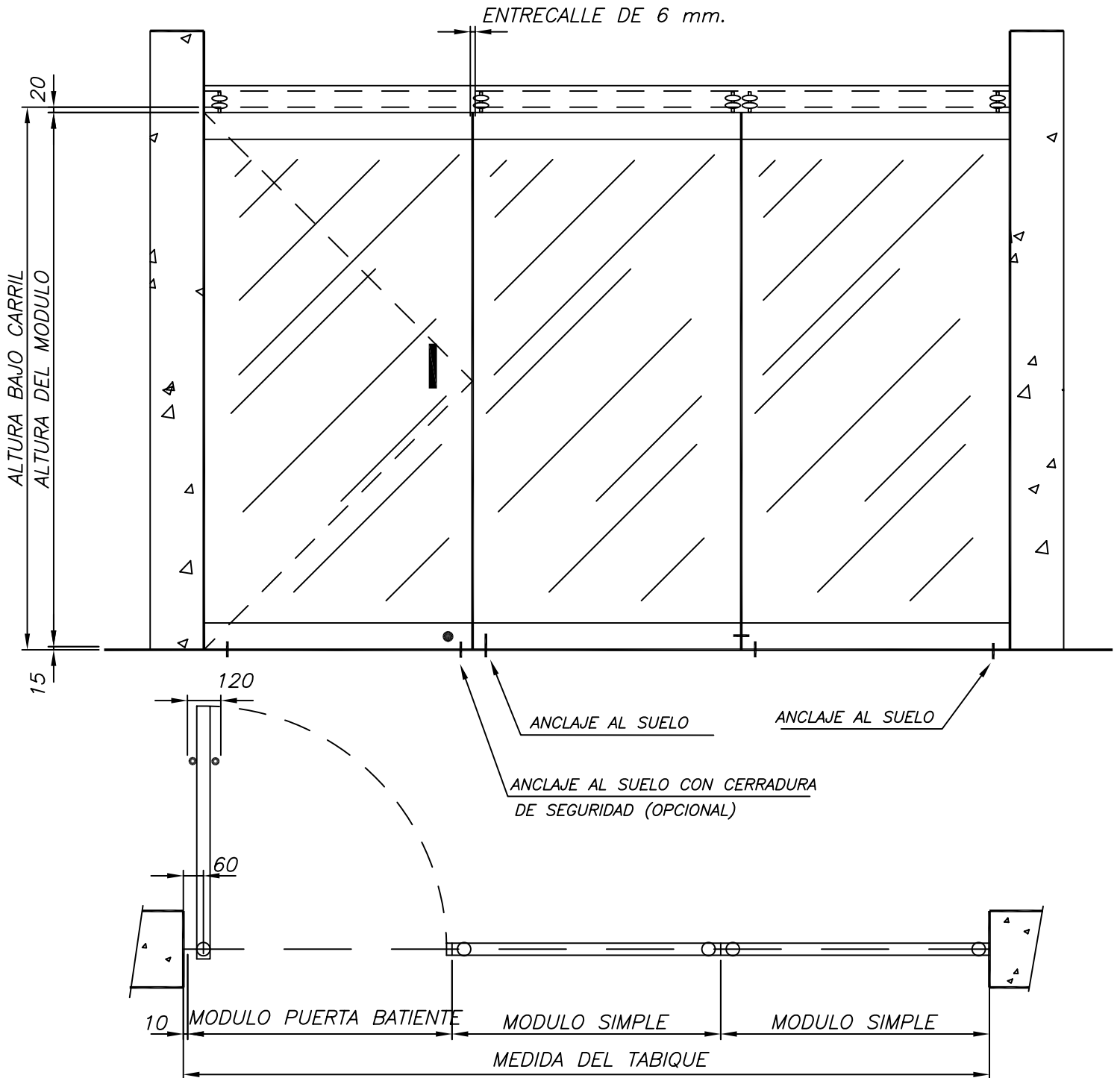

	H. MAX. BAJO CARRIL	ANCHO MAX.
MODULO SIMPLE	3400 mm.	1300 mm.
MODULO BATIENTE	3000 mm.	1000 mm.
MODULO PUERTA	3000 mm.	800 mm.
MODULO PUERTA DOBLE	3000 mm.	800 mm.
CONSULTAR MEDIDAS ESPECIALES		

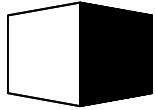

REITER
GLASS WALL

TABIQUE MOVIL ACRISTALADO CON PUERTA SIMPLE

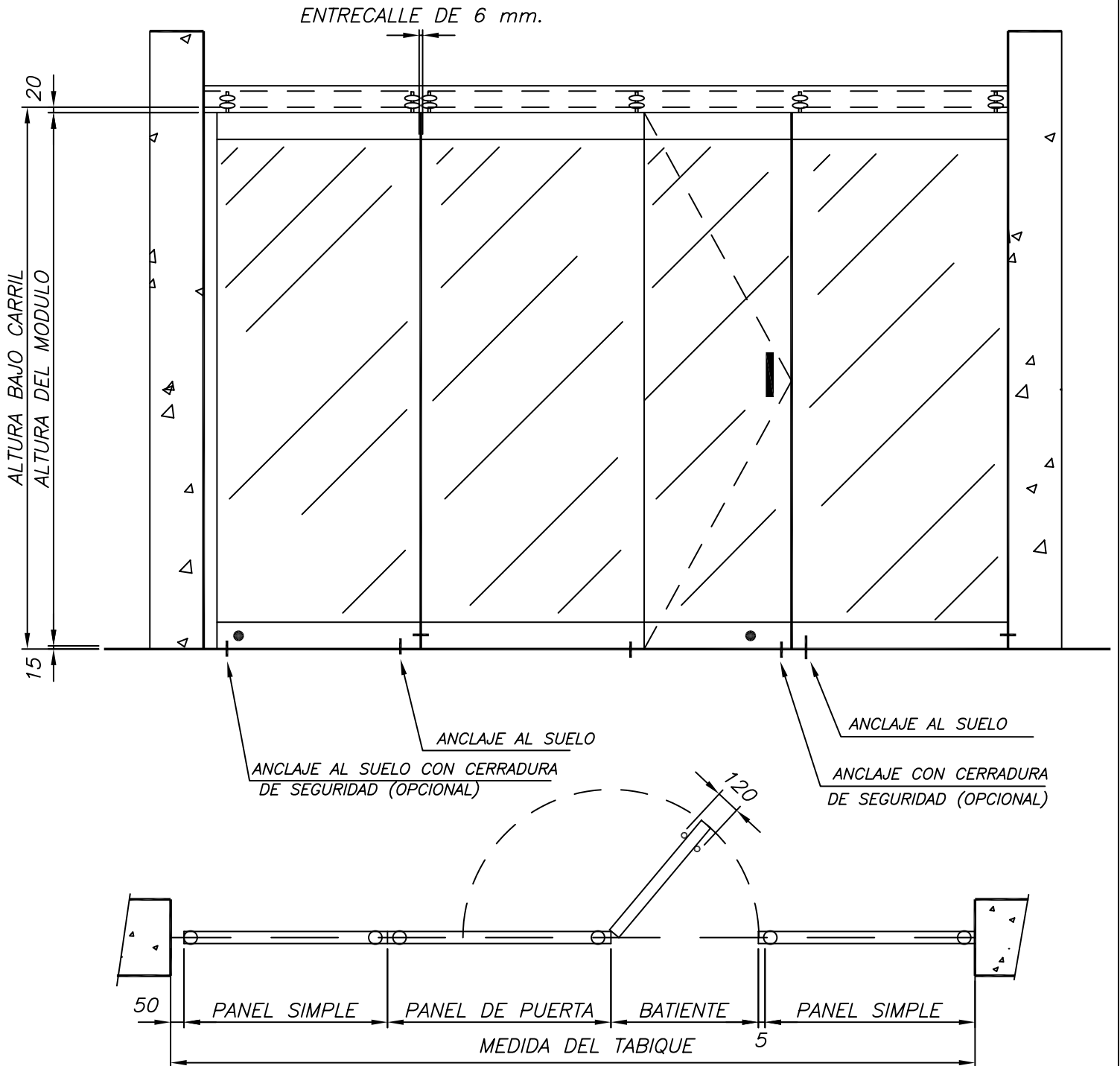

	H. MAX. BAJO CARRIL	ANCHO MAX.
MODULO SIMPLE	3400 mm.	1300 mm.
MODULO BATIENTE	3000 mm.	1000 mm.
MODULO PUERTA	3000 mm.	800 mm.
MODULO PUERTA DOBLE	3000 mm.	800 mm.
CONSULTAR MEDIDAS ESPECIALES		

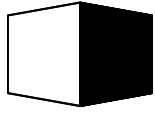

REITER
GLASS WALL

TABIQUE MOVIL ACRISTALADO CON PUERTA DOBLE

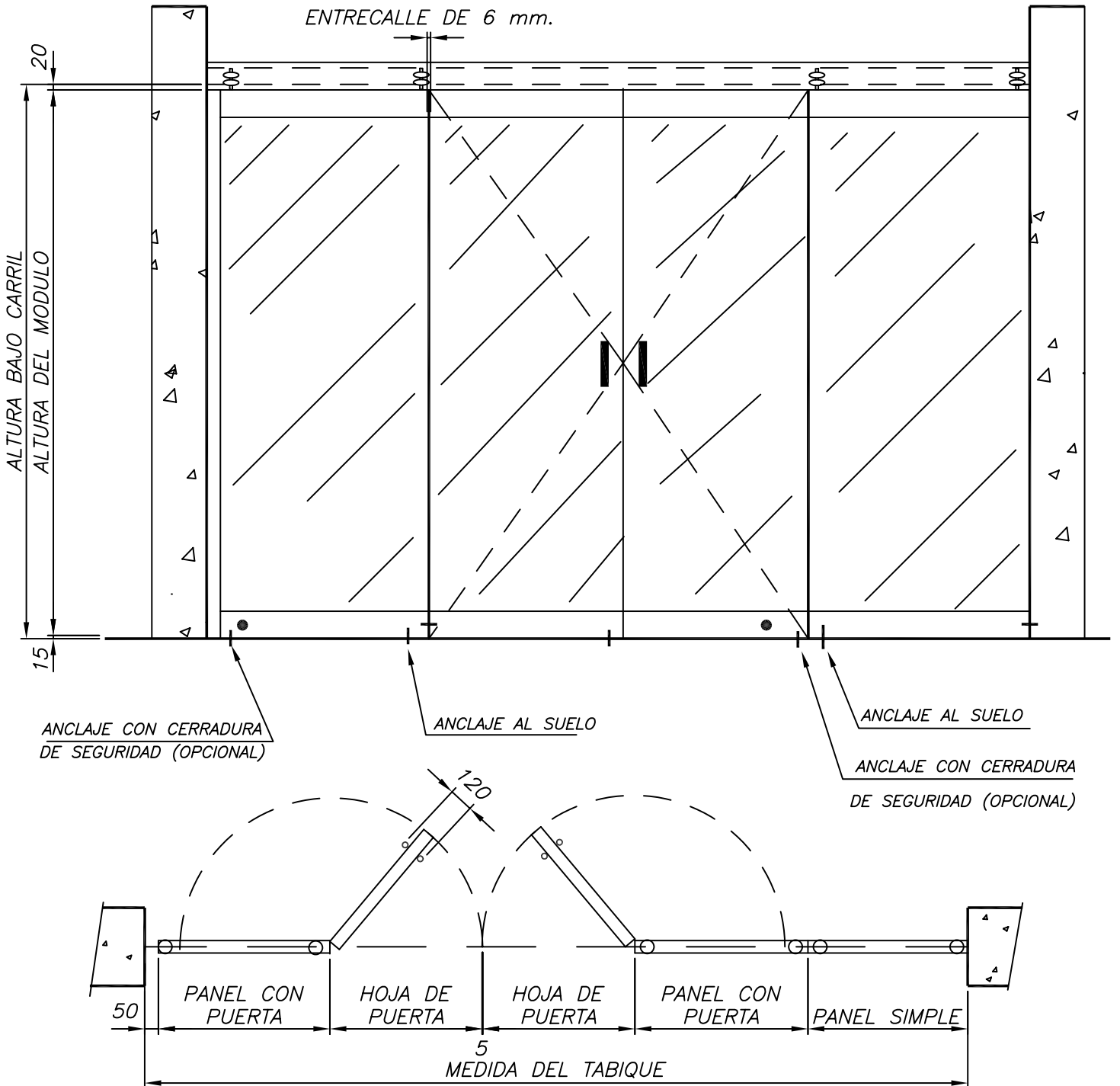

	H. MAX. BAJO CARRIL	ANCHO MAX.
MODULO SIMPLE	3400 mm.	1300 mm.
MODULO BATIENTE	3000 mm.	1000 mm.
MODULO PUERTA	3000 mm.	800 mm.
MODULO PUERTA DOBLE	3000 mm.	800 mm.
CONSULTAR MEDIDAS ESPECIALES		

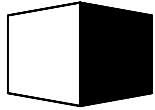

REITER
GLASS WALL

TABIQUE MOVIL ACRISTALADO GLASS WALL
CON MODULO DE PUERTA SIMPLE

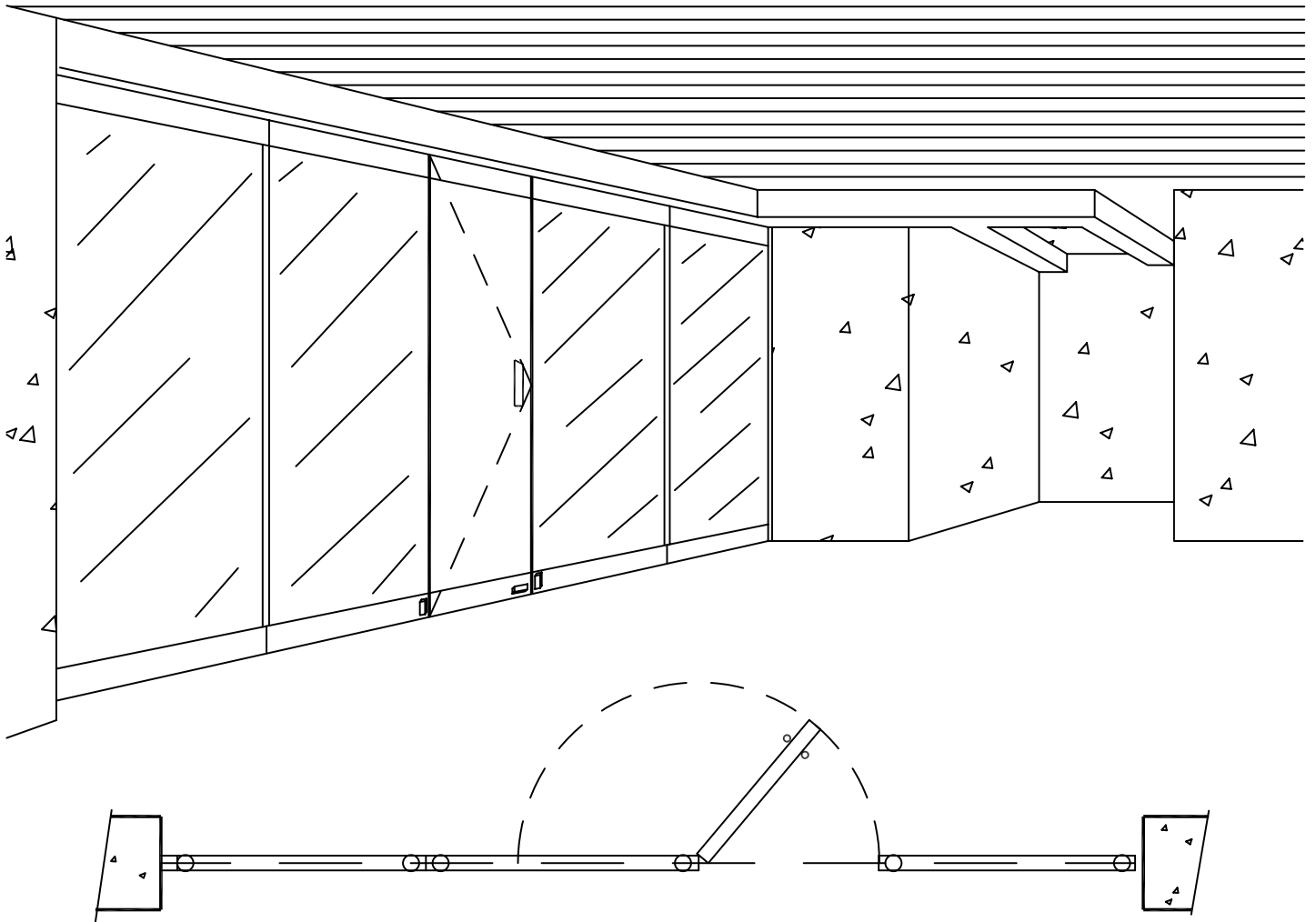

	H. MAX. BAJO CARRIL	ANCHO MAX.
MODULO SIMPLE	3400 mm.	1300 mm.
MODULO BATIENTE	3000 mm.	1000 mm.
MODULO PUERTA	3000 mm.	800 mm.
MODULO PUERTA DOBLE	3000 mm.	800 mm.
CONSULTAR MEDIDAS ESPECIALES		

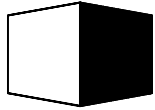

REITER
GLASS WALL

TABIQUE MOVIL ACRISTALADO GLASS WALL
CON MODULO DE PUERTA DOBLE

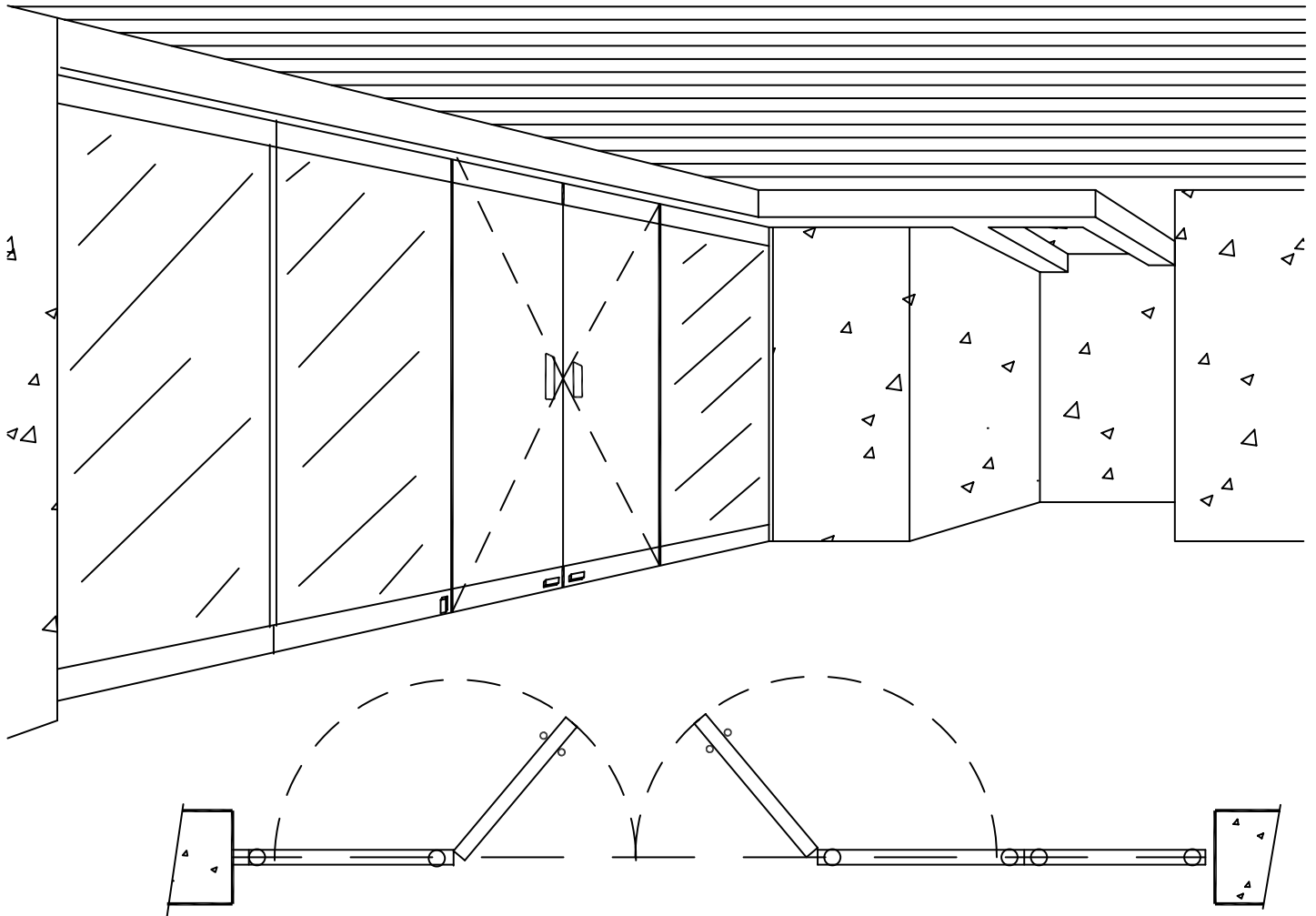

	H. MAX. BAJO CARRIL	ANCHO MAX.
MODULO SIMPLE	3400 mm.	1300 mm.
MODULO BATIENTE	3000 mm.	1000 mm.
MODULO PUERTA	3000 mm.	800 mm.
MODULO PUERTA DOBLE	3000 mm.	800 mm.
CONSULTAR MEDIDAS ESPECIALES		

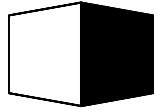

REITER
GLASS WALL

TABIQUES MOVILES ACRISTALADOS GLASS WALL
MODO DE ALMACENAMIENTO DE MODULOS SIMPLES

1/ *Liberar el pasador del primer módulo.*

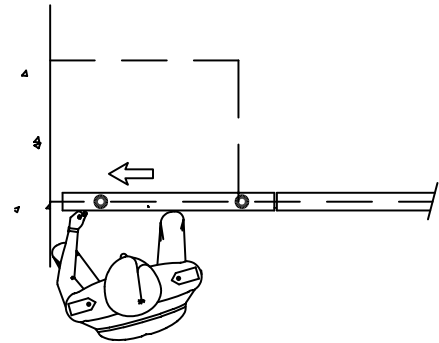

2/ *Girar y almacenar el módulo.*

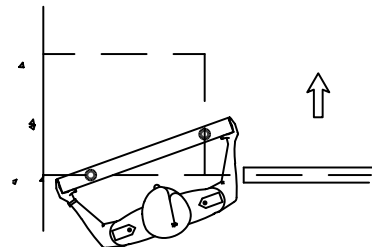

3/ *Liberar el segundo módulo y girarlo en la zona de almacenamiento.*

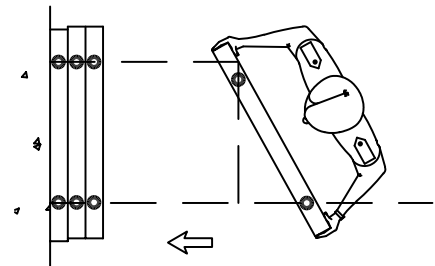

4/ *Poner el último módulo en la zona de almacenamiento.*

Todos los movimientos deben hacerse suavemente.

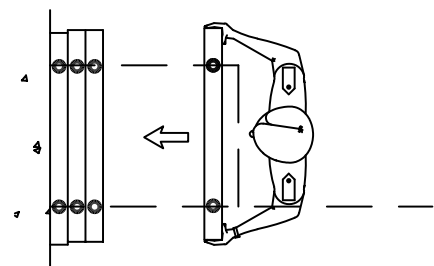

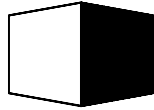

REITER
GLASS WALL

TABIQUES MOVILES ACRISTALADOS GLASS WALL
MODO DE ALMACENAMIENTO CON MODULO BATIENTE

1/ *Abrir el módulo batiente.*

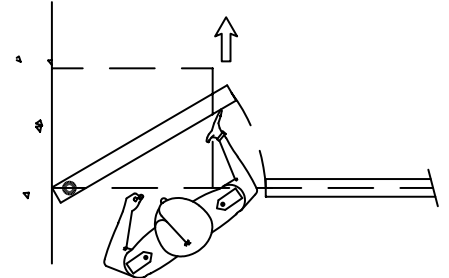

2/ *Liberar el pasador del módulo siguiente*

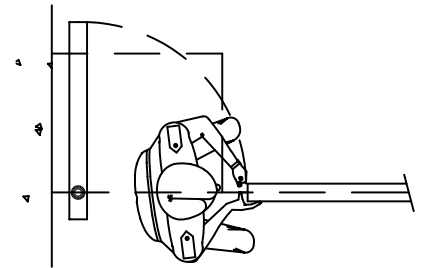

3/ *Empujar el panel hasta la zona de almacenamiento.*

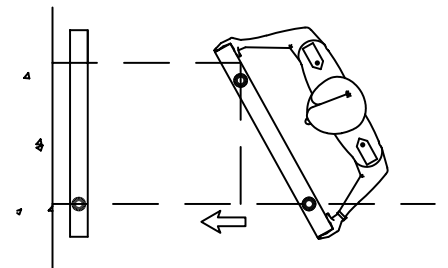

4/ *Poner el último panel en la zona de almacenamiento.*

Todos los movimientos deben hacerse suavemente.

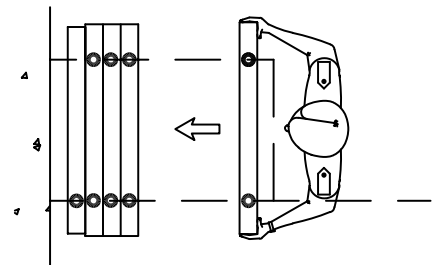

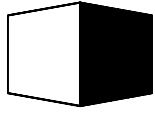

REITER
GLASS WALL

TABIQUES MOVILES ACRISTALADOS GLASS WALL
EJEMPLOS DE ALMACENAMIENTO

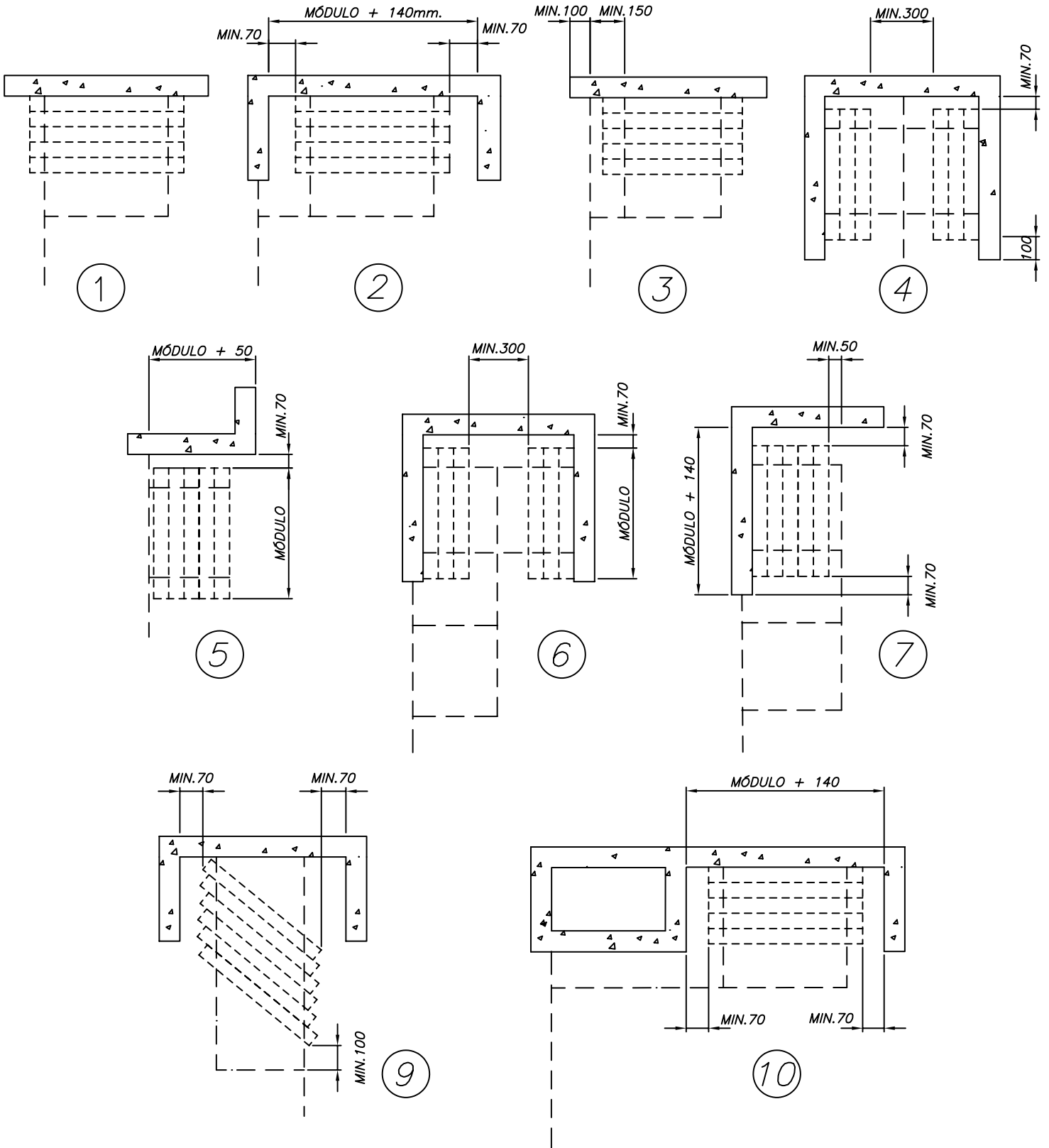

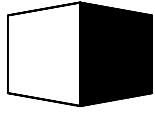

REITER
GLASS WALL

TABIQUES MOVILES ACRISTALADOS GLASS WALL
EJEMPLOS DE ALMACENAMIENTO

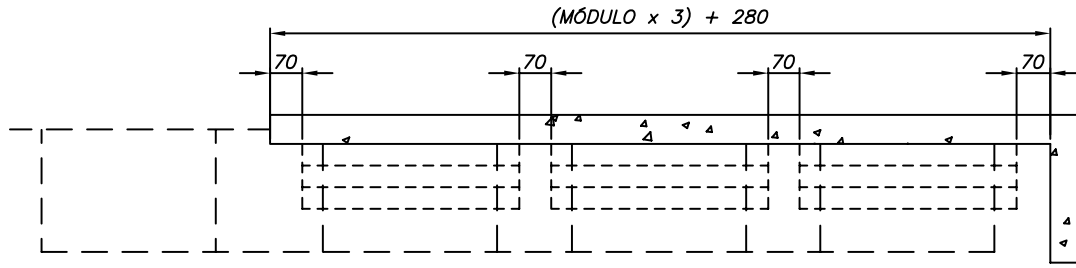

11

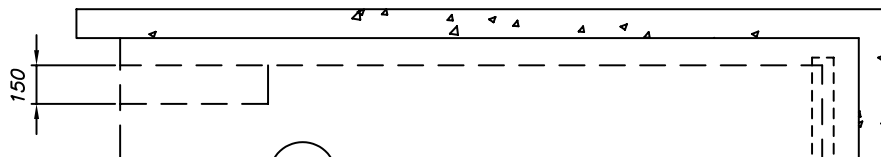

12

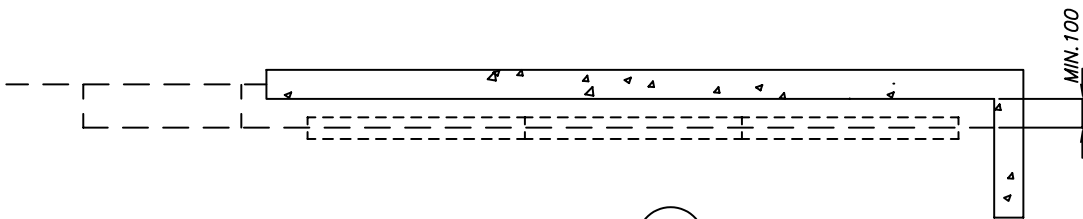

13

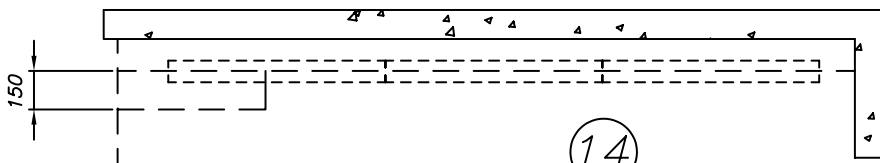

14

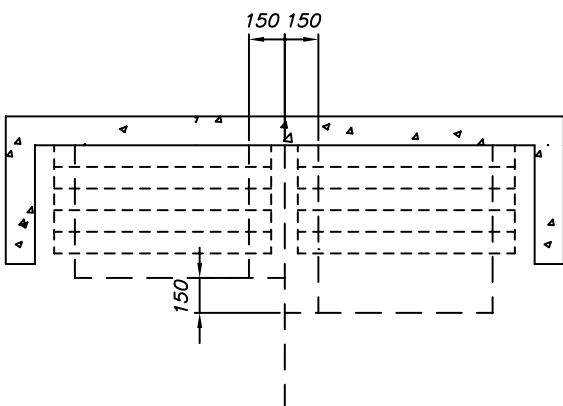
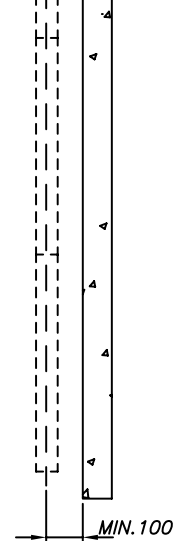

15

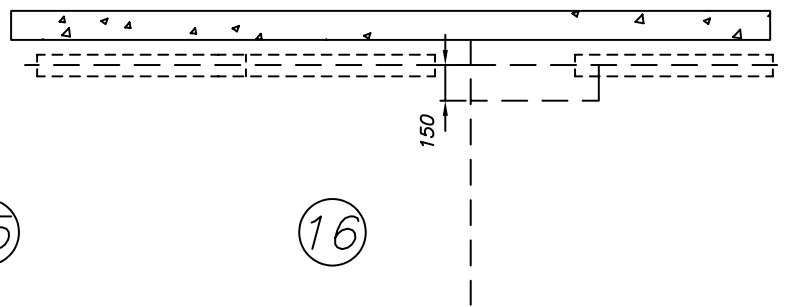

16

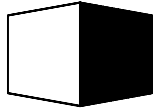

REITER
GLASS WALL

DIMENSIONES MINIMAS DE ALMACENAMIENTO
DE TABIQUES MOVILES ACRISTALADOS GLASS WALL

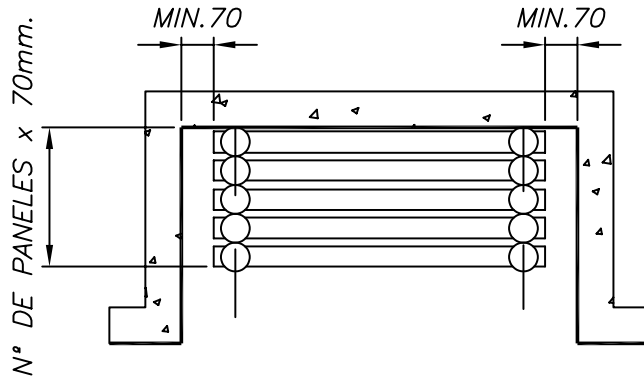

DIMENSIONES DE UN PANEL SIMPLE

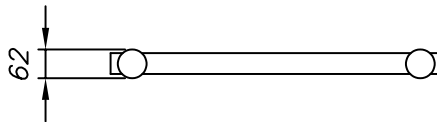

DIMENSIONES DE UN PANEL PUERTA BATIENTE

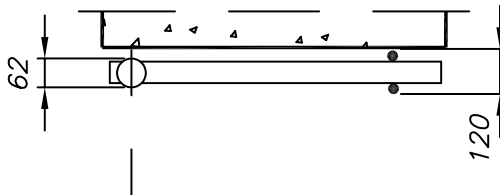

DIMENSIONES DE UN PANEL CON PUERTA

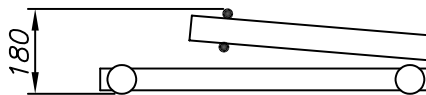

DIMENSIONES DE DOS PANELES CON PUERTA.

